

Wymiary prowadnic

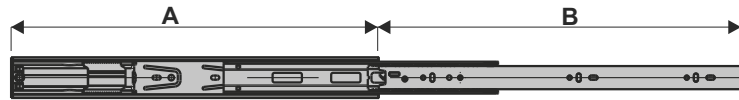

A	250	300	350	400	450	500	550
B	210±2	288±2	338±2	396±2	444±2	492±2	546±2

Mocowanie prowadnic do korpusu

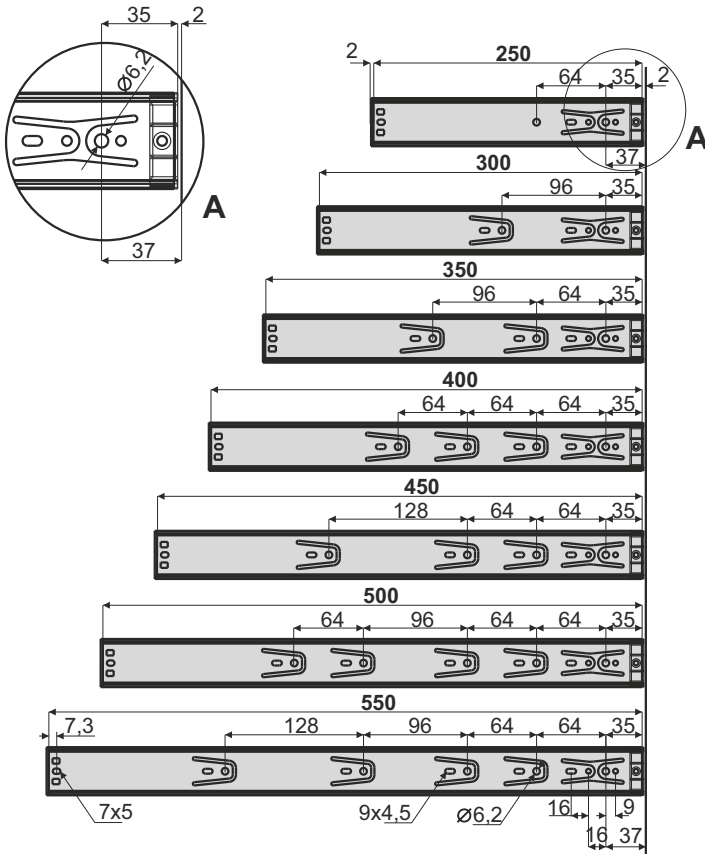

Mocowanie prowadnic do szuflady

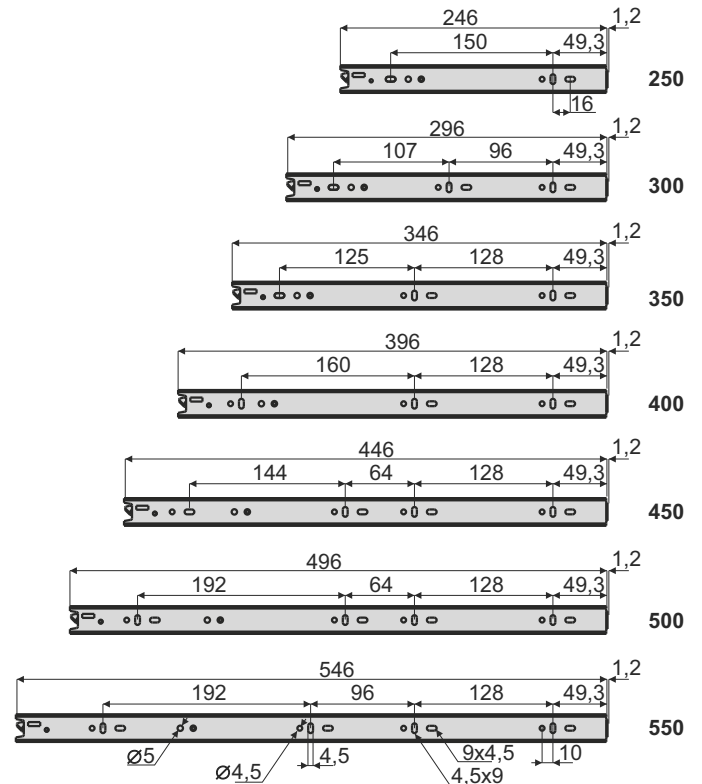

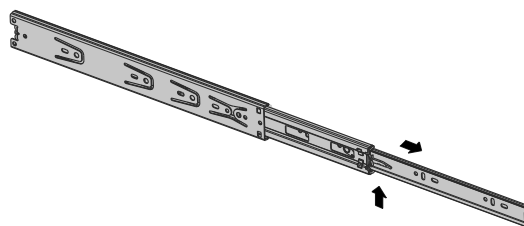
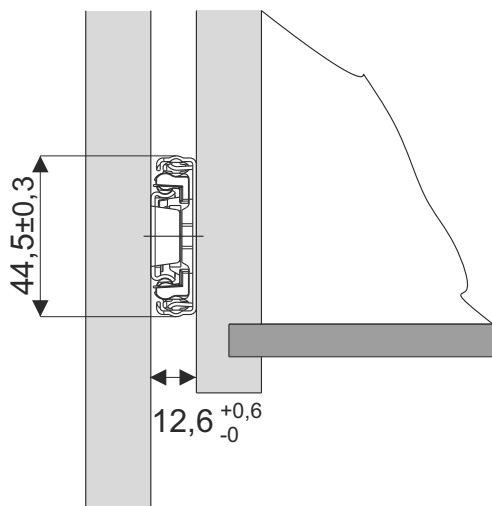

Wymiary prowadnic

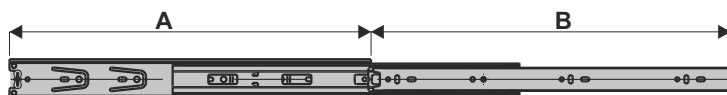

A	250	300	350	400	450	500	550
B	247±2	298±2	348±2	398±2	448±2	497±2	548±2

Mocowanie prowadnic do korpusu

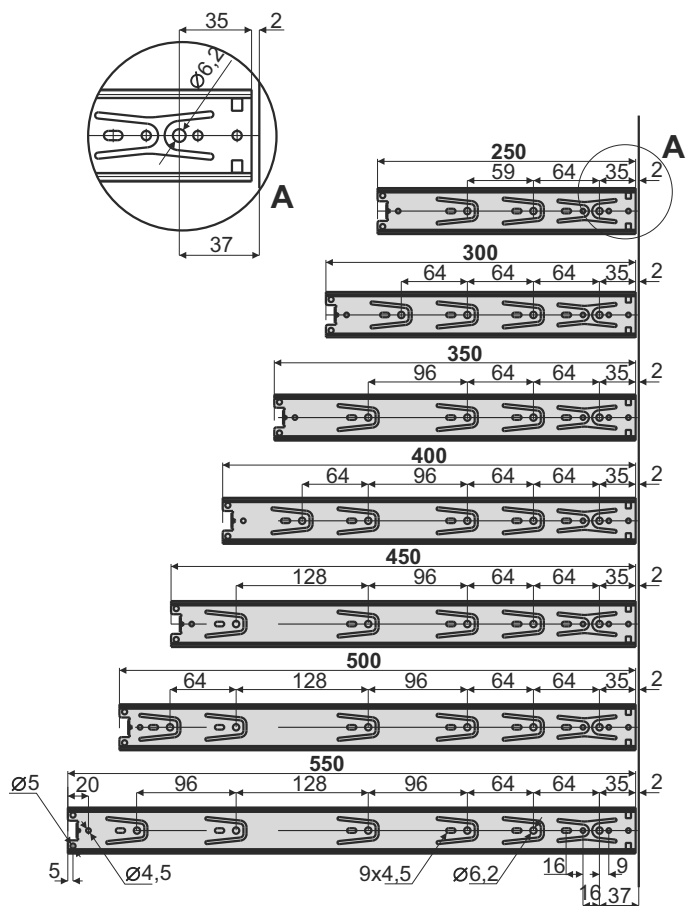

Mocowanie prowadnic do szuflady

